



# Test Certificate

Part Automated Disintegration Basket  
(for 6 Tubes)

Part Number 23130-01

Serial Number 7346 - 7368

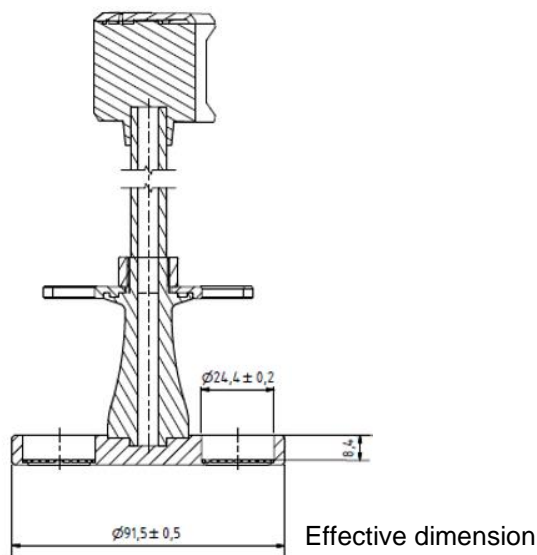

	USP / Ph.Eur	Tolerances
<b>Dimensions</b>	Bottom plate $\varnothing$	90.0 mm $\pm 2.0$ mm
	Distance to sieve	6.75 mm $\pm 1.75$ mm
	6 Holes $\varnothing$	24 mm $\pm 2.00$ mm
<b>Material</b>	PMMA, POM, PVC, PA	

USP / Ph.Eur conformity (acc. USP701 / Ph Eur 2.9.1) :

The design of the basket-rack assembly may be varied somewhat, provided the specifications for the glass tubes and the screen mesh size are maintained.

(separate Certificates for Glass tube #12514 and Sieve plate # 23440-01)

The accuracy of the above mentioned part dimensions have been examined. All relevant measurements are within tolerance and the factory acceptance test has passed.

Aesch, 2021-11-09

Bruno Balli  
SOTAX Quality Management  
SOTAX AG | Nordring 1 | 4147 Aesch | Switzerland