



Test Certificate

Part Automated Disintegration Basket
(for 3 Tubes)

Part Number 23140-01

Serial Number SK3.7241 – SK3.7244

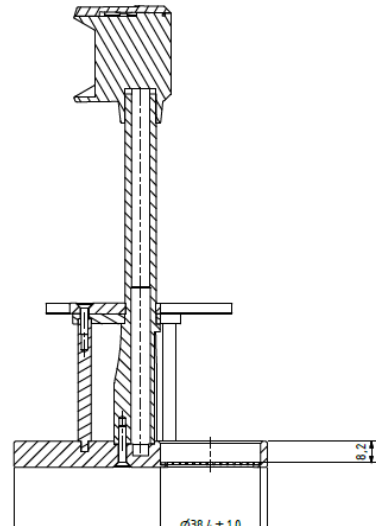

	Effective dimension	Ph.Eur	Tolerances
Dimensions $\varnothing 97 \pm 0,1$	Bottom plate \varnothing	97.0 mm	- - mm
	Bottom thickness	9.0 mm	- - mm
	Distance to sieve*	8.20 mm	- - mm
	3 Holes \varnothing	38.0 mm	1.5 mm
Material	PMMA, POM, PVC, PA		

* (Not in Ph.Eur)

Ph.Eur conformity (acc. Ph Eur 2.9.1) :

The design of the basket-rack assembly may be varied somewhat, provided the specifications for the glass tubes and the screen mesh size are maintained.

(separate Certificates for Glass tube #8825-1 and Sieve plate # 23443-01)

The accuracy of the above mentioned part dimensions have been examined. All relevant measurements are within tolerance and the factory acceptance test has passed.

Aesch, 2023-06-16

Michael Schmidlin
SOTAX Quality Management
SOTAX AG | Nordring 1 | 4147 Aesch | Switzerland